

Orkus 40 (520x400)

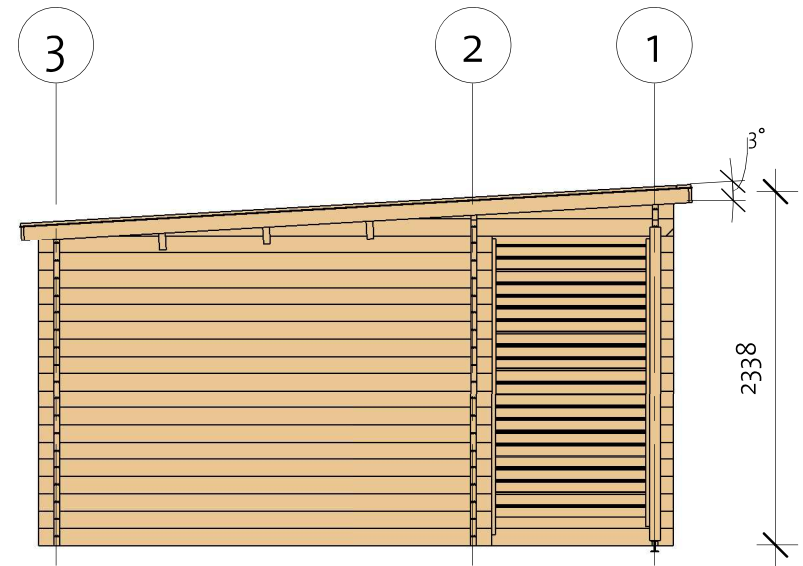

Orkus 40 (520x400)

Floor Plan

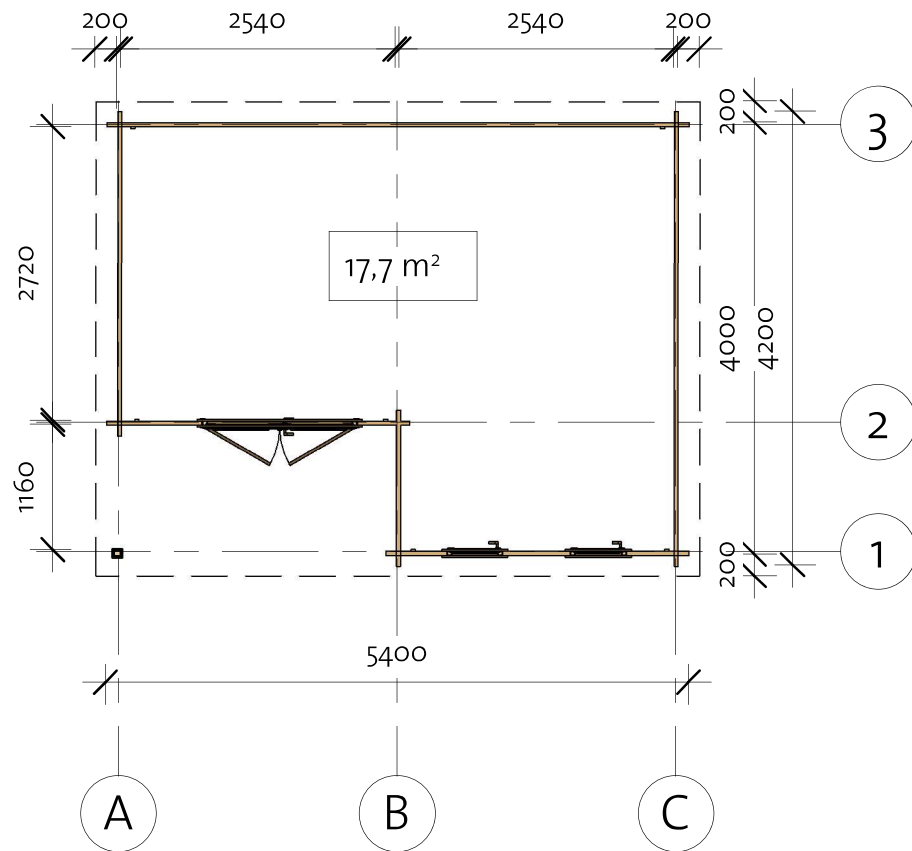
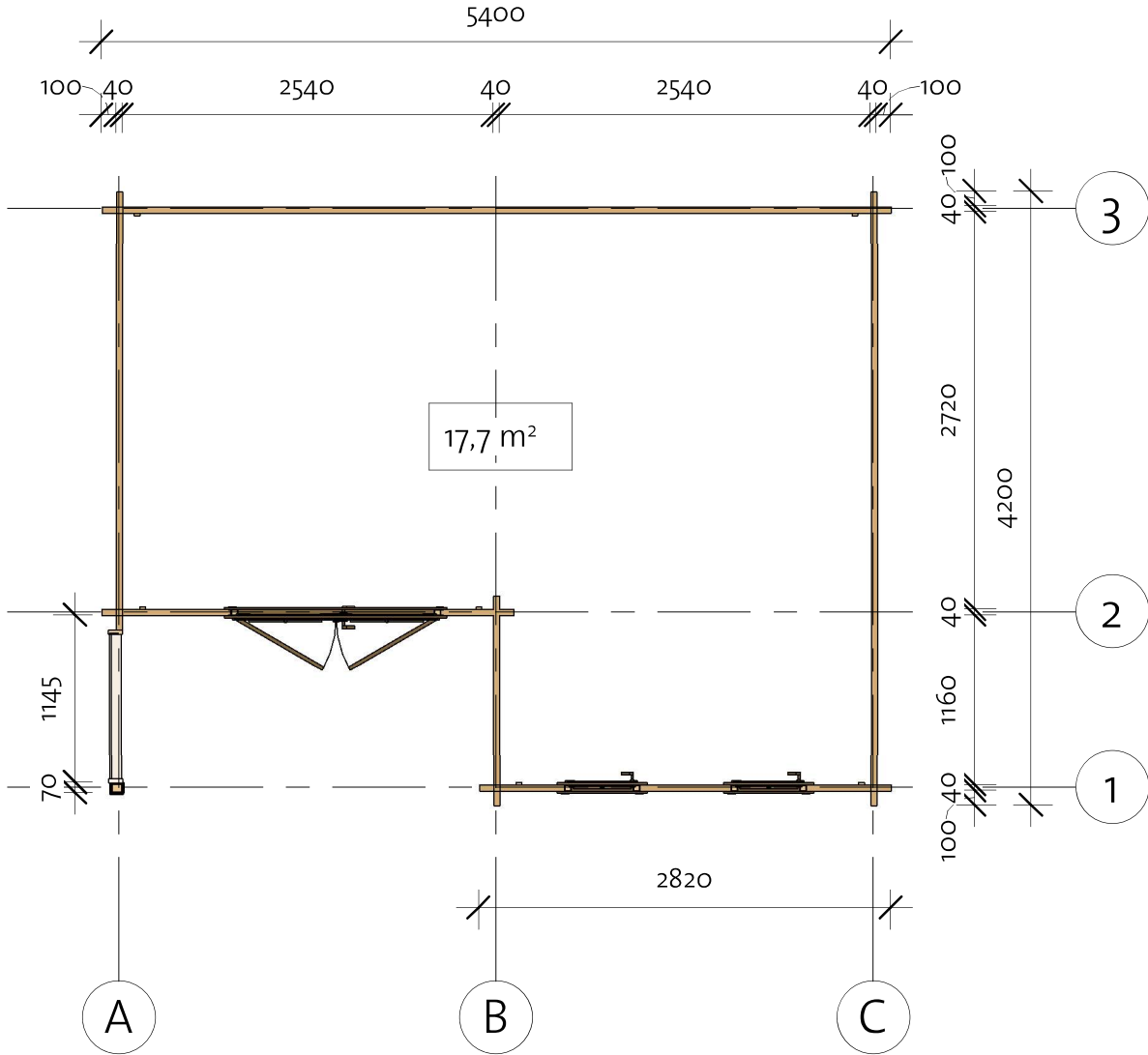

Orkus 40 (520x400)

Wall 1

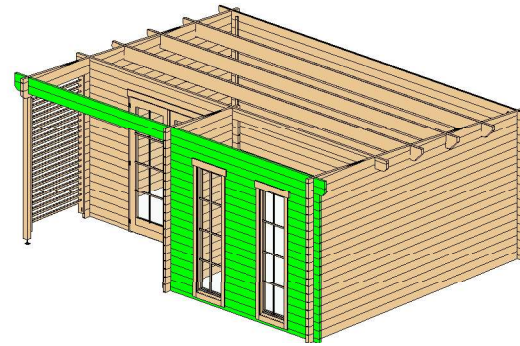

| Wall 1 | | | |
|--------|---------|-------|------------|
| Mark | Profile | Count | Cut Length |

| | | | |
|-------|--------|----|------|
| 1BL-1 | 40x57 | 1 | 2820 |
| 1LG-1 | 40x114 | 1 | 5600 |
| 1LG-2 | 40x114 | 34 | 580 |
| 1LG-3 | 40x114 | 1 | 2820 |
| 1LG-4 | 40x114 | 17 | 620 |
| 1TL-1 | 40x114 | 1 | 5600 |

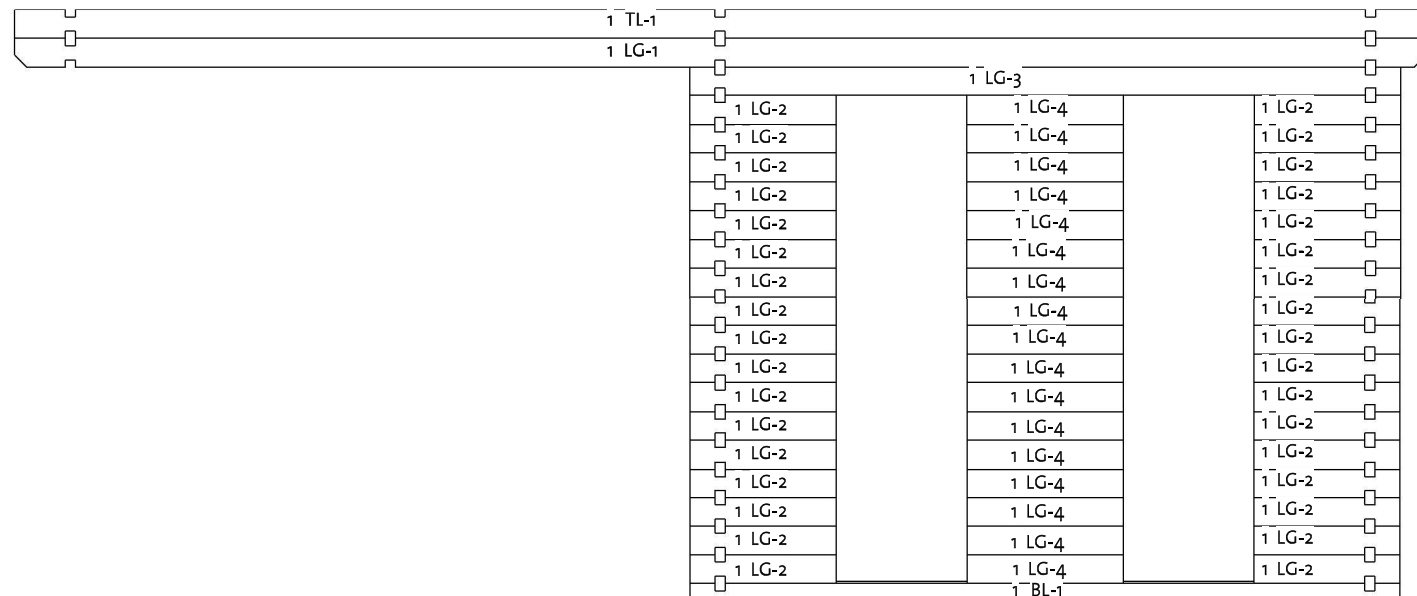

| Log Profile Wall 1 | |
|--------------------|---------|
| Profile | Profile |

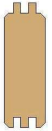
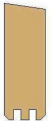
| | |
|--------|---|
| 40x57 |  |
| 40x114 |  |
| 40x114 |  |

Orkus 40 (520x400)

Wall 2

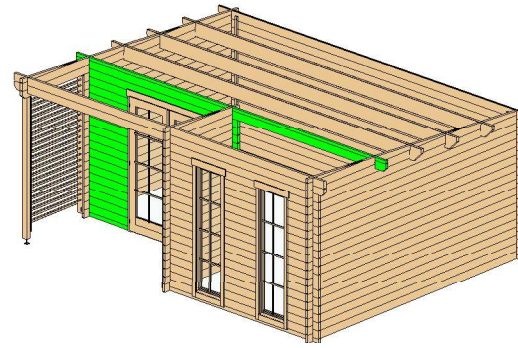

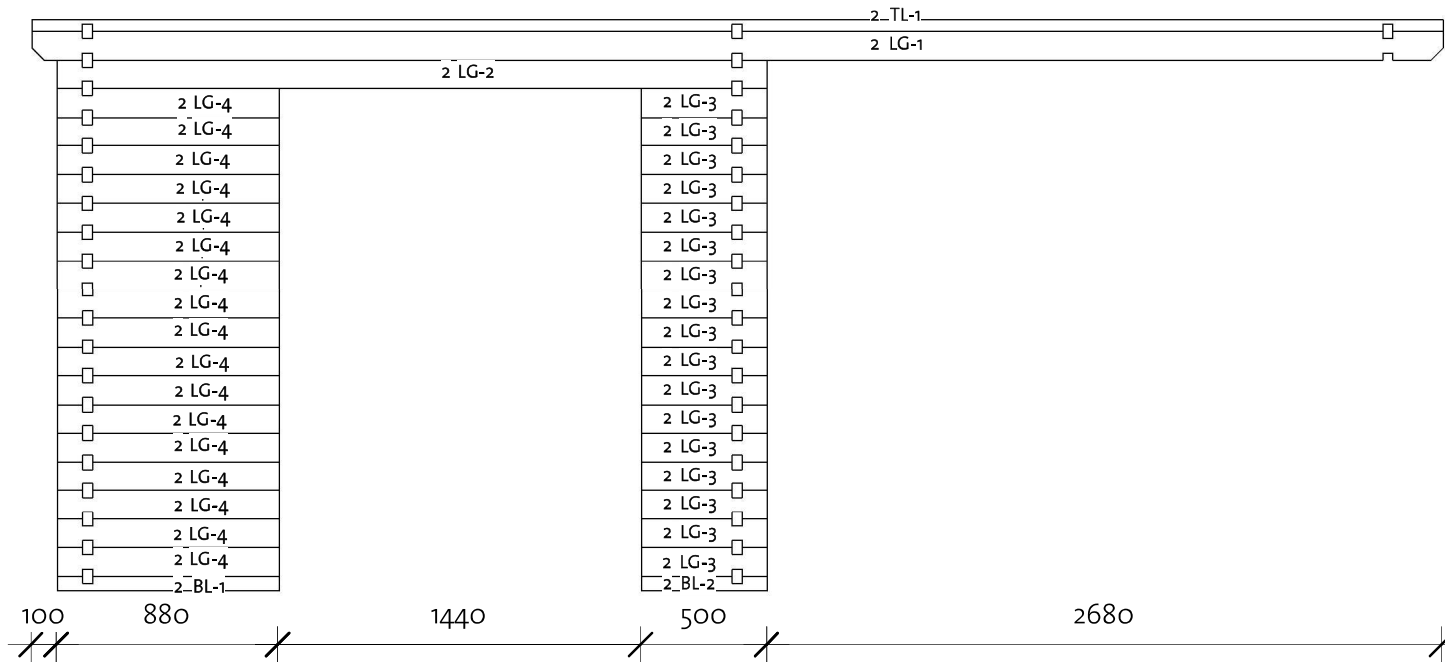

| Wall 2 | | | |
|--------|---------|-------|------------|
| Mark | Profile | Count | Cut Length |

| | | | |
|-------|--------|----|------|
| 2BL-1 | 40x57 | 1 | 880 |
| 2BL-2 | 40x57 | 1 | 500 |
| 2LG-1 | 40x114 | 1 | 5600 |
| 2LG-2 | 40x114 | 1 | 2820 |
| 2LG-3 | 40x114 | 17 | 500 |
| 2LG-4 | 40x114 | 17 | 880 |
| 2TL-1 | 40x45 | 1 | 5600 |



| Log Profile Wall 2 | |
|--------------------|---------|
| Profile | Profile |

| | |
|--------|---|
| 40x45 |  |
| 40x57 |  |
| 40x114 |  |

Orkus 40 (520x400)

Wall 3

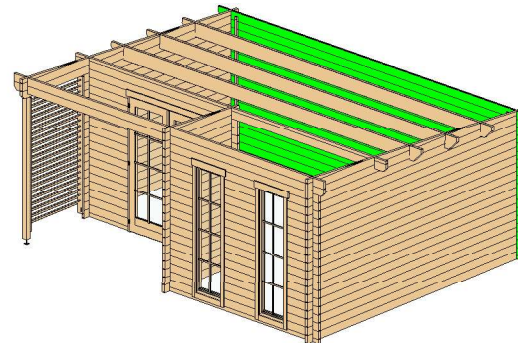

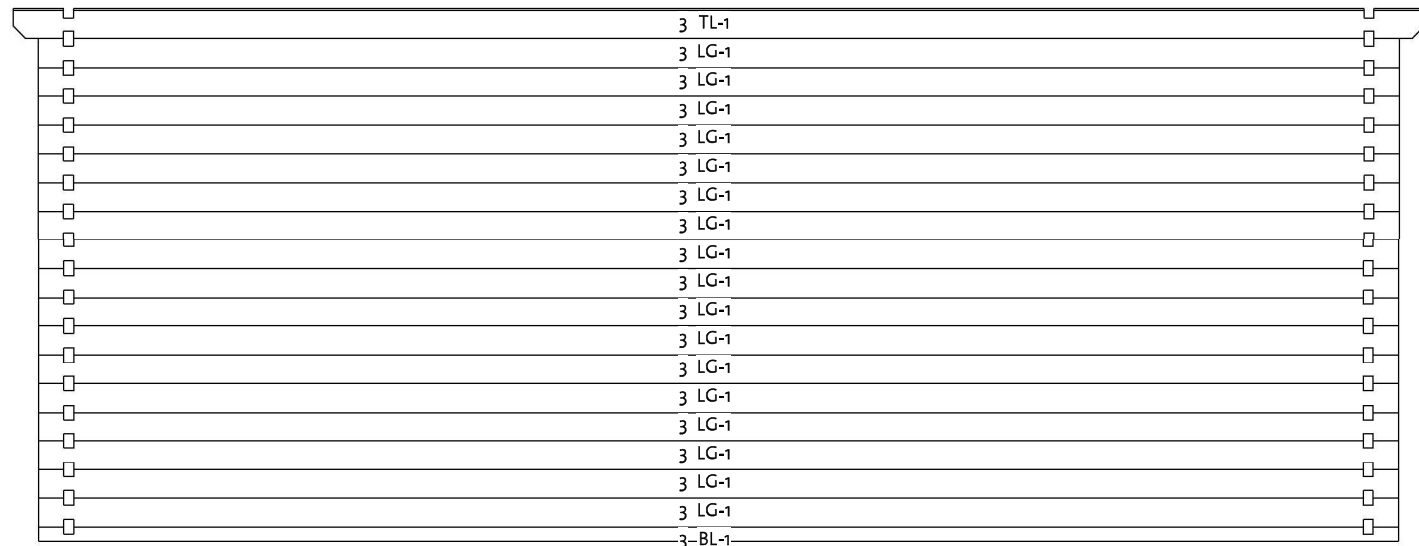

| Wall 3 | | | |
|--------|---------|-------|------------|
| Mark | Profile | Count | Cut Length |

| | | | |
|-------|--------|----|------|
| 3BL-1 | 40x57 | 1 | 5400 |
| 3LG-1 | 40x114 | 17 | 5400 |
| 3TL-1 | 40x114 | 1 | 5600 |



| Log Profile Wall 3 | |
|--------------------|---------|
| Profile | Profile |

| | |
|--------|---|
| 40x57 |  |
| 40x114 |  |
| 40x114 |  |

100
//

5400

100
//

Orkus 40 (520x400)

Wall A

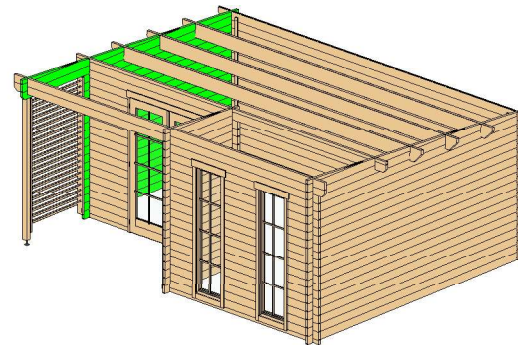

| Wall A | | | |
|--------|---------|-------|------------|
| Mark | Profile | Count | Cut Length |

| | | | |
|--------|--------|----|------|
| ALG-1* | 40X114 | 1 | 1090 |
| ALG-2* | 40X114 | 1 | 3070 |
| ALG-3* | 40X114 | 1 | 4200 |
| ALG-4* | 40X114 | 1 | 3000 |
| ALG-5 | 40X114 | 17 | 3000 |

* Gable - delivered premounted

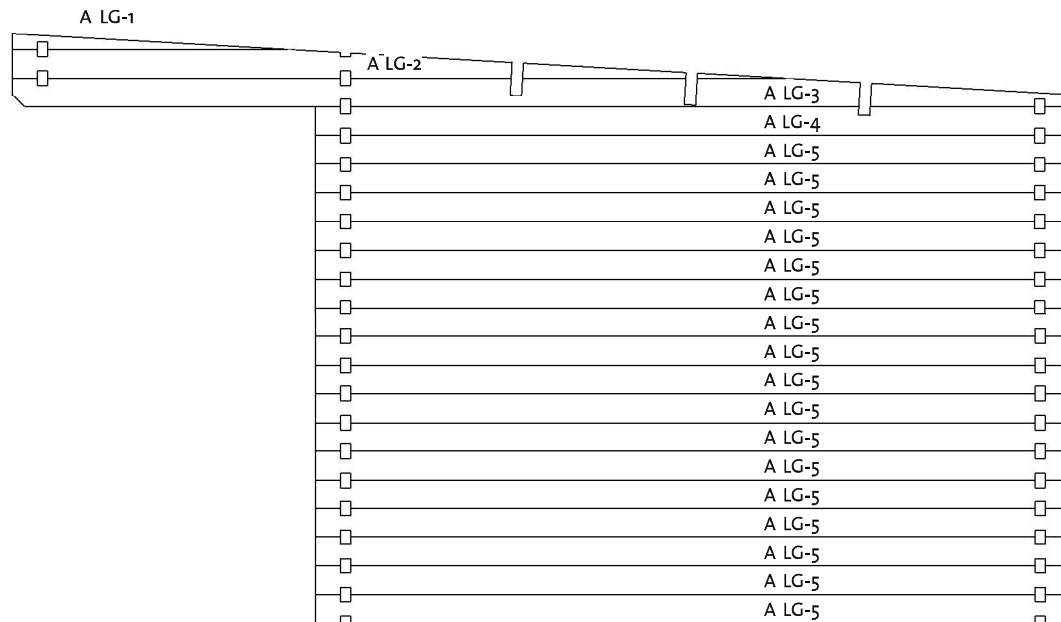

919080713_220422

| Log Profile Wall A | |
|--------------------|---------|
| Profile | Profile |

| | |
|--------|--|
| 40X114 | |
|--------|--|

Orkus 40 (520x400)

Wall B

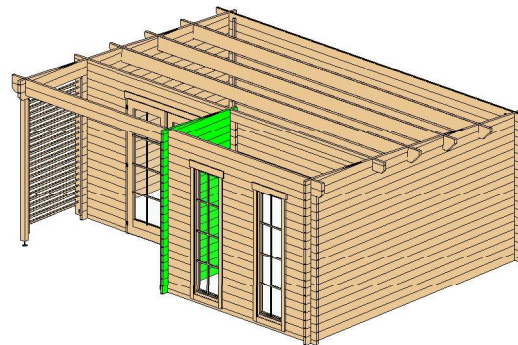

| Wall B | | | |
|--------|---------|-------|------------|
| Mark | Profile | Count | Cut Length |

| | | | |
|--------|--------|----|------|
| BLG-1* | 40X114 | 1 | 1090 |
| BLG-2* | 40X114 | 1 | 1440 |
| BLG-3 | 40X114 | 19 | 1440 |

* Gable - delivered premounted

| | | |
|---|--------|---|
| □ | B_LG-1 | □ |
| □ | B LG-2 | □ |
| □ | B LG-3 | □ |
| □ | B LG-3 | □ |
| □ | B LG-3 | □ |
| □ | B LG-3 | □ |
| □ | B LG-3 | □ |
| □ | B LG-3 | □ |
| □ | B LG-3 | □ |
| □ | B LG-3 | □ |
| □ | B LG-3 | □ |
| □ | B LG-3 | □ |
| □ | B LG-3 | □ |
| □ | B LG-3 | □ |
| □ | B LG-3 | □ |
| □ | B LG-3 | □ |
| □ | B LG-3 | □ |
| □ | B LG-3 | □ |
| □ | B LG-3 | □ |
| □ | B LG-3 | □ |
| □ | B LG-3 | □ |
| □ | B LG-3 | □ |
| □ | B LG-3 | □ |
| □ | B LG-3 | □ |

| Log Profile Wall B | |
|--------------------|---------|
| Profile | Profile |

| | |
|--------|---|
| 40X114 |  |
|--------|---|

Orkus 40 (520x400)

Wall C

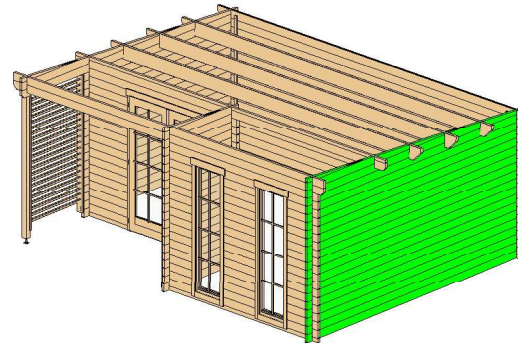

| Wall C | | | |
|--------|---------|-------|------------|
| Mark | Profile | Count | Cut Length |

| | | | |
|--------|--------|----|------|
| CLG-1* | 40X114 | 1 | 1090 |
| CLG-2* | 40X114 | 1 | 3070 |
| CLG-3* | 40X114 | 1 | 4200 |
| CLG-4* | 40X114 | 1 | 4200 |
| CLG-5 | 40X114 | 17 | 4200 |

* Gable - delivered premounted

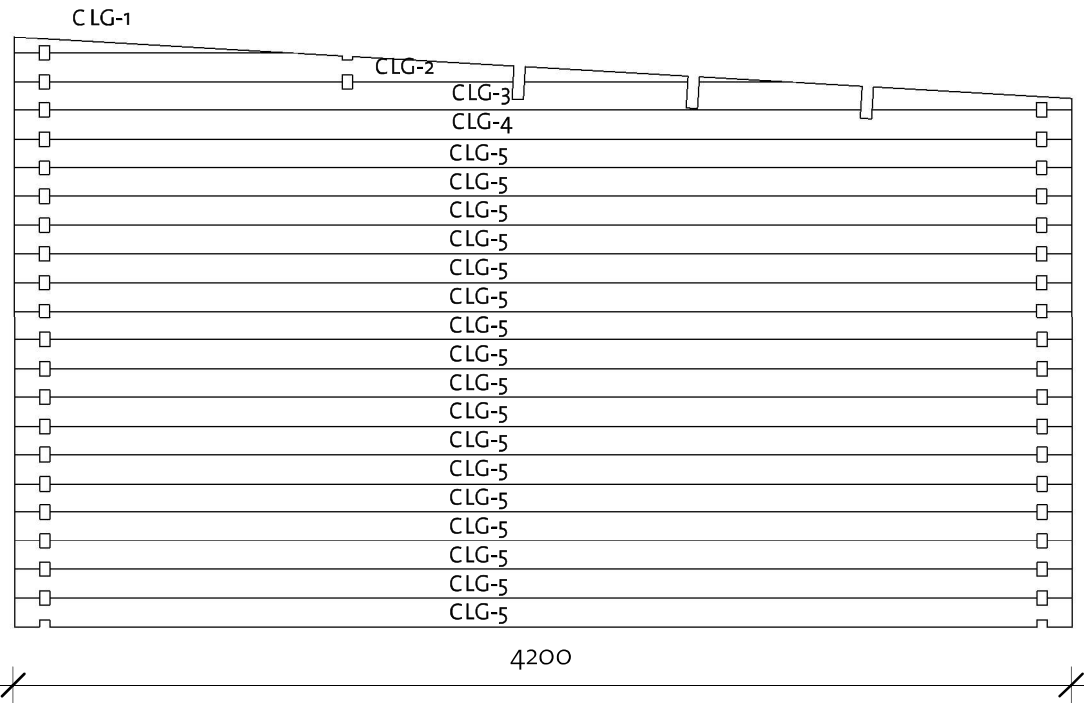



| Log Profile Wall C | |
|--------------------|---------|
| Profile | Profile |

| | |
|--------|--|
| 40X114 | |
|--------|--|

Orkus 40 (520x400)

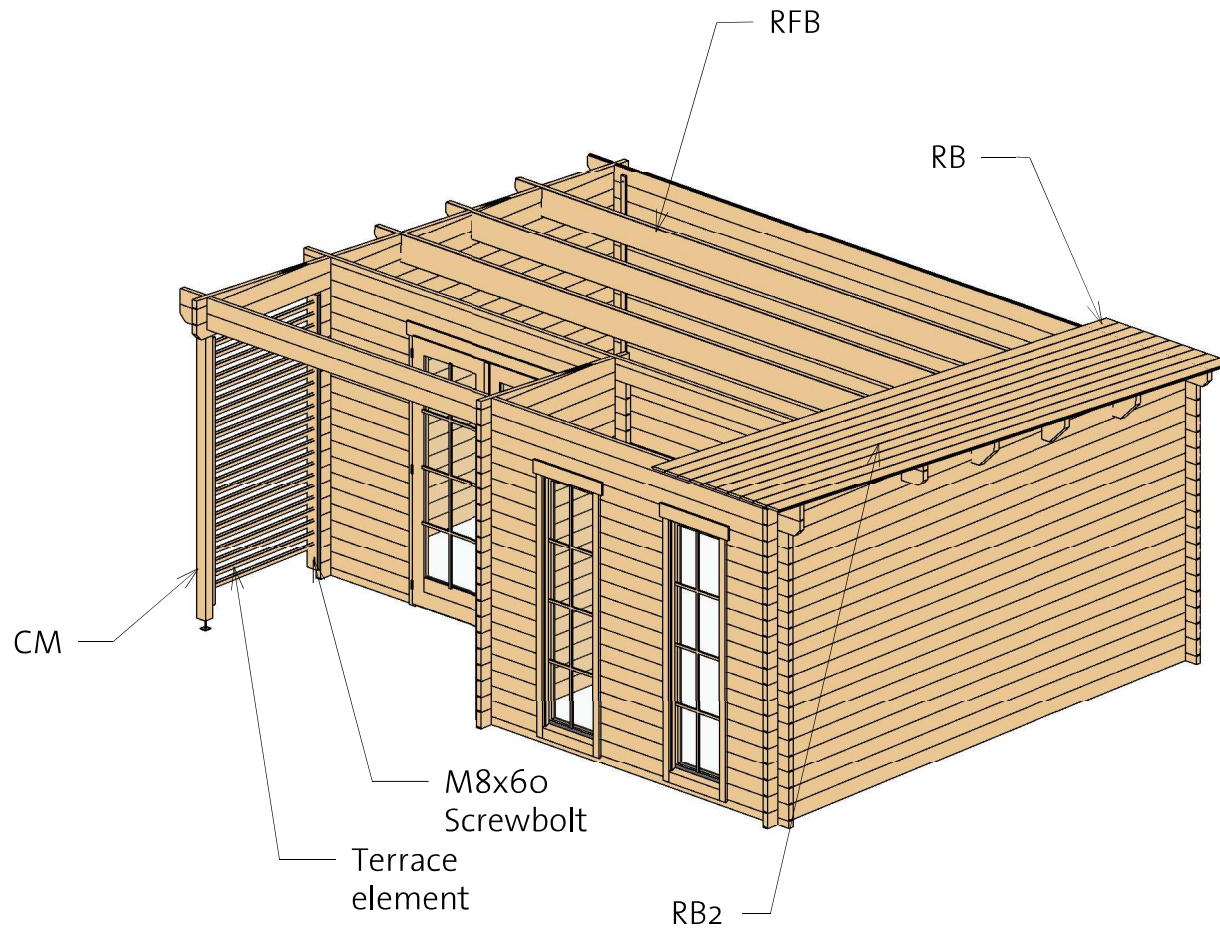
Roof 1



| Roof | | | | |
|------|-------------|---|-------|--------|
| Mark | Type | Profile | Count | Length |
| RB | 17x114 |  | 50 | 4406 |
| RFB | Beam 45x195 |  | 3 | 5600 |

| Terrace element | | | |
|-----------------|-------|-------|--------|
| Mark | Type | Count | Length |
| TS1 | 28x95 | 1 | 1906 |
| TS2 | 28x95 | 1 | 1960 |
| TS3 | 18x95 | 22 | 1009 |

| Columns | | | |
|---------|------------|-------|--------|
| Mark | Profile | Count | Length |
| CM | Post 80x70 | 1 | 2074 |

Orkus 40 (520x400)

Roof 2

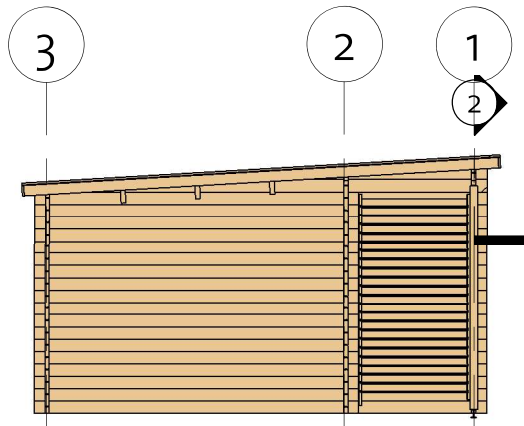

2 Facia

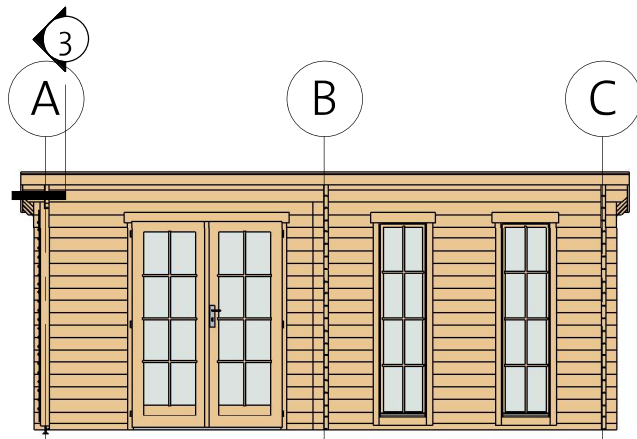
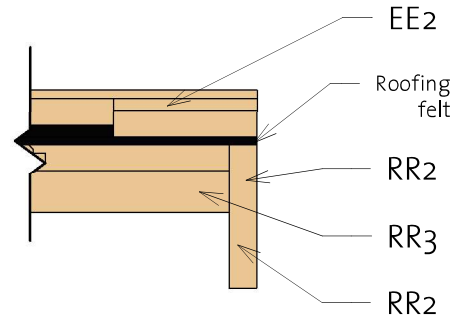

3 Roof Reinforcement

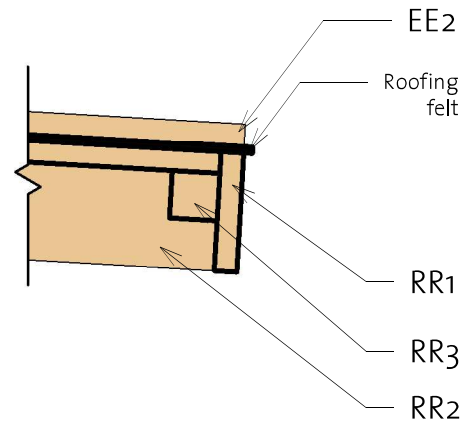

Fascia Schedule

| Mark | Type | Profile | Count | Length |
|------|--------------------------|---------|-------|--------|
| EE1 | Eave Edging 18x95 | | 1 | 5636 |
| EE2 | Eave Edging 18x95 | | 2 | 4345 |
| RR1 | Roof reinforcement 18x95 | | 2 | 5636 |
| RR2 | Roof reinforcement 18x95 | | 2 | 4406 |
| RR3 | Roof reinforcement 38x38 | | 2 | 5600 |

Orkus 40 (520x400)

Extras

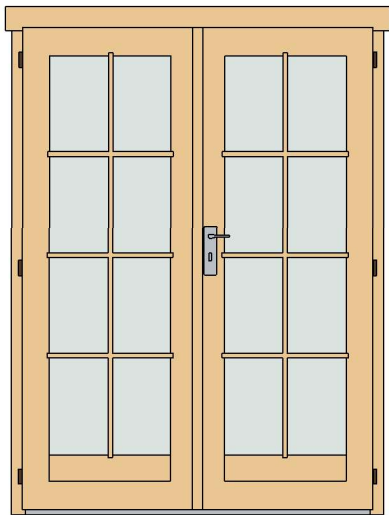

| Door Schedule | | | | |
|---------------|-----------------------------|-------|--------|-------|
| Model | Type | Width | Height | Count |
| CDD3R | Classic double door 3 right | 1425 | 1955 | 1 |
| DCB8 | Door Crossbar 8 | -- | -- | 2 |

| Type | Count |
|----------------------|-------|
| Windboard 18x40x2200 | 6 |



| Fasteners/Extras | | |
|------------------|------|-------|
| Name | Type | Count |

| | | |
|----------------------|------------|-----|
| Hitblock | 300-400 mm | |
| Adjustable post foot | | 1 |
| Screwbolt | M8 x 60 | 1 |
| Bolts | M8x70 | 18 |
| Screws | 5,0 x 70 | 25 |
| Screws | 6,0 x 140 | 35 |
| Screws | 4,0 x 40 | 410 |

| Window Schedule | | | | |
|-----------------|-------------------------|-------|--------|-------|
| Mark | Type | Width | Height | Count |
| CW21R | Classic window 21 right | 515 | 1890 | 2 |
| WCB8 | Windows Crossbar 8 | -- | -- | 2 |

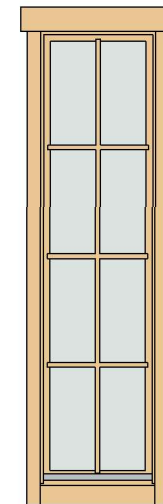

Orkus 40 (520x400)

List of all items 1



| Columns | | | |
|---------|---------|-------|--------|
| Mark | Profile | Count | Length |

| | | | |
|----|------------|---|------|
| CM | Post 80x70 | 1 | 2074 |
|----|------------|---|------|





| Terrace element | | | |
|-----------------|------|-------|--------|
| Mark | Type | Count | Length |

| | | | |
|-----|-------|----|------|
| TS1 | 28x95 | 1 | 1906 |
| TS2 | 28x95 | 1 | 1960 |
| TS3 | 18x95 | 22 | 1009 |

| Roof | | | | |
|------|------|---------|-------|--------|
| Mark | Type | Profile | Count | Length |

| | | | | |
|-----|----------------|---|----|------|
| RB | 17x114 |  | 50 | 4406 |
| RFB | Beam 45x195 |  | 3 | 5600 |

| Fascia Schedule | | | | |
|-----------------|------|---------|-------|--------|
| Mark | Type | Profile | Count | Length |

| | | | | |
|-----|------------------------------------|---|---|------|
| EE1 | Eave Edging 18x95 |  | 1 | 5636 |
| EE2 | Eave Edging 18x95 |  | 2 | 4345 |
| RR1 | Roof reinforce ment 18x95 |  | 2 | 5636 |
| RR2 | Roof reinforce ment 18x95 |  | 2 | 4406 |
| RR3 | Roof reinforce ment 38x38 |  | 2 | 5600 |

Orkus 40 (520x400)

List of all items 2

| Wall 1 | | | |
|--------|---------|-------|------------|
| Mark | Profile | Count | Cut Length |

| | | | |
|-------|--------|----|------|
| 1BL-1 | 40x57 | 1 | 2820 |
| 1LG-1 | 40x114 | 1 | 5600 |
| 1LG-2 | 40x114 | 34 | 580 |
| 1LG-3 | 40x114 | 1 | 2820 |
| 1LG-4 | 40x114 | 17 | 620 |
| 1TL-1 | 40x114 | 1 | 5600 |

| Wall 3 | | | |
|--------|---------|-------|------------|
| Mark | Profile | Count | Cut Length |

| | | | |
|-------|--------|----|------|
| 3BL-1 | 40x57 | 1 | 5400 |
| 3LG-1 | 40x114 | 17 | 5400 |
| 3TL-1 | 40x114 | 1 | 5600 |

| Wall A | | | |
|--------|---------|-------|------------|
| Mark | Profile | Count | Cut Length |

| | | | |
|--------|--------|----|------|
| ALG-1* | 40x114 | 1 | 1090 |
| ALG-2* | 40x114 | 1 | 3070 |
| ALG-3* | 40x114 | 1 | 4200 |
| ALG-4* | 40x114 | 1 | 3000 |
| ALG-5 | 40x114 | 17 | 3000 |

| Wall B | | | |
|--------|---------|-------|------------|
| Mark | Profile | Count | Cut Length |

| | | | |
|--------|--------|----|------|
| BLG-1* | 40x114 | 1 | 1090 |
| BLG-2* | 40x114 | 1 | 1440 |
| BLG-3 | 40x114 | 19 | 1440 |

| Wall 2 | | | |
|--------|---------|-------|------------|
| Mark | Profile | Count | Cut Length |



| | | | |
|-------|--------|----|------|
| 2BL-1 | 40x57 | 1 | 880 |
| 2BL-2 | 40x57 | 1 | 500 |
| 2LG-1 | 40x114 | 1 | 5600 |
| 2LG-2 | 40x114 | 1 | 2820 |
| 2LG-3 | 40x114 | 17 | 500 |
| 2LG-4 | 40x114 | 17 | 880 |
| 2TL-1 | 40x45 | 1 | 5600 |

| Wall C | | | |
|--------|---------|-------|------------|
| Mark | Profile | Count | Cut Length |



| | | | |
|--------|--------|----|------|
| CLG-1* | 40x114 | 1 | 1090 |
| CLG-2* | 40x114 | 1 | 3070 |
| CLG-3* | 40x114 | 1 | 4200 |
| CLG-4* | 40x114 | 1 | 4200 |
| CLG-5 | 40x114 | 17 | 4200 |

* Gable - delivered premounted

| Log profiles | |
|--------------|---------|
| Profile | Profile |

| | |
|-------|---|
| 40x57 |  |
| 40x45 |  |

| Log profiles | |
|--------------|---------|
| Profile | Profile |

| | |
|--------|---|
| 40x114 |  |
| 40x114 |  |